

LU Series Handle

Sure Grip "LU" Series Control Grip is our large handle commonly found on forestry, mining and construction machinery. It is designed to offer up to 8 switches in the faceplate as well as the option for up to 2 trigger switches or operator presence switch. An expansion pod can be installed that will be mounted on either side of the handle, for an additional 2 buttons, 1 Slider or 1 Rocker module. A keypad can also be installed on the left or right of the handle for an additional 10 buttons.

The "LU" Series Control Grip can be customized with all the Sure Grip Handle Options such as; Slider modules, Rocker modules, Microjoystick, LED's, toggle switches and maintained switches. Accessories such as bushing adapters, studs and sealed connectors are also available (Please refer to Handle Accessories on website).

The cases are molded from a high impact plastic polymer into a comfortable shape for a rugged and lightweight control handle for extreme duty applications. The standard Sure Grip switches are covered with our patented overlay design.

Standard configurations are available for next day shipping (please contact factory).

Features:

- Sealing up to IP67
- Rugged design
- Overlay customizable
- Switches tested to 10 million operations
- Multiple trigger options available
- Supports up to 2 Microjoysticks
- Supports up to 5 Sliders or Rocker Modules
- Supports a 10 button keypad
- Supports up to 10 faceplate switches
- Supports Expansion Pod, i.e. - Forward/Neutral/Reverse functions



Specifications are subject to change without notice

Momentary Switch Specifications

Switch Options:	Load	Voltage	Operating Temp
Unsealed Standard - IP40	3 A	30 Vdc	-25°C to +85°C
Sealed Switch - IP67	1 A	30 Vdc	-40°C to +85°C
Unsealed Gold contact - IP40	100 mA	30 Vdc	-25°C to +85°C
Sealed Gold contact - IP67	100 mA	30 Vdc	-40°C to +85°C

Maintained Switch Specifications

Switch Options:	Load	Voltage	Operating Temp
Push Button	3 A	30 Vdc	-30°C to +85°C

Toggle Switch Specifications

Switch Options:	Load	Voltage	Operating Temp
Toggle Switches	3 A	30 Vdc	-30°C to +85°C
Functions	On-On / On-Off-On / Mom-Off-Mom / On-Off-Mom		

LED Specifications

LED Options:	Load	Voltage	Operating Temp
LED	20 mA	5, 12, 24 Vdc	-40°C to +85°C
Colours Available	Red / Green / Tri-colour (R/Y/G)		

Cable Specifications

Cable Options:	WR-09B	WR-10B	WR-13B	WR-15B
Conductor	9	10	13	15
Material	Tinned Copper	Tinned Copper	Tinned Copper	Tinned Copper
Strand	19 Twisted	7 Twisted	19 Twisted	7 Twisted
AWG	20	22	22	22
Insulation	SR-PVC	SR-PVC	SR-PVC	SR-PVC
Outer Jacket	PVC FT4	PVC FT4	PVC FT4	PVC FT4
Operating Temperature	-40°C to +105°C	-40°C to +105°C	-40°C to +105°C	-40°C to +105°C

Dimensions

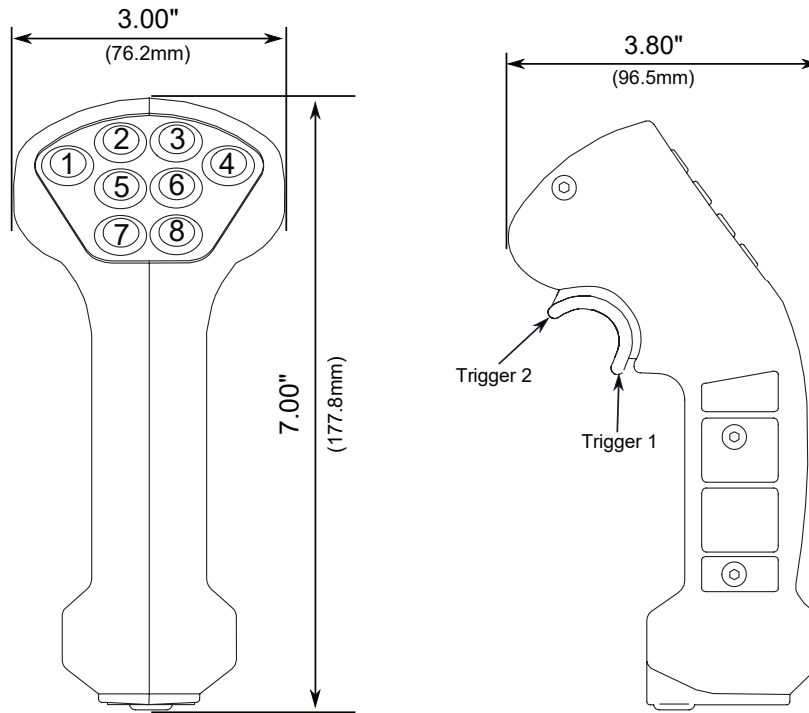

Typical Wiring

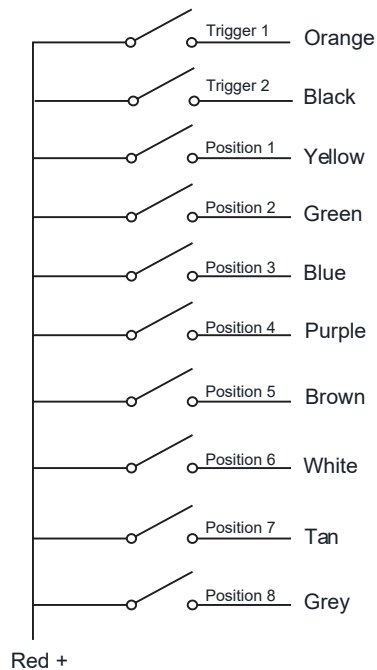

Ordering Guide

Order Instructions:

- Each box has a color and number, which corresponds to joystick options below. Please review each option, as this will help you with choosing your part number. (Refer to our technical guides for more information on product options)
- If you require a handle please look at handle ordering guides.
- If a desired joystick option is not available contact a sales representative to discuss if there are alternative solutions for your application.
- Enter your configured part number in the empty boxes provided below and contact a friendly Sure Grip sales representative to place your order.

Your configured part number:



LU -

1 2 3 4 4 4 4 4 4 4 4 4 4 4 5 6 7 8 9 10 10

Example: LU - B - B - NN - A M J F Z Z A A N N - N - A - N - N - 000 - D - E

P1 P2 P3 P4 P5 P6 P7 P8 P9 P10

*Faceplate Location Reference

1. Handle Color	
B - Black G - Grey	
2. Switch Style	
N - No Switch A - UnSealed 3Amp Switch B - Sealed 1Amp Switch C - Unseald 100mA Switch D - Sealed 100mA Switch	
3. Trigger Options	
NN - None SN - Single DN - Double PN - Proportional AN - Single Ma Trigger BN - Double Ma Trigger NO - OP (Operator Presence)	
4. Function Types	
N - None <u>1 Position</u> A - Mo Switch *B - Ma Switch *C - Toggle 2Ma *D - Toggle 3Ma *E - Toggle 3Mo *F - LED Red *G - LED Green *H - LED Bi-Colour (R/G)	Mo - Momentary Ma - Maintained F - Friction
J - Slider Module 3Mo K - Slider Module 3Ma L - Slider Module F U - Slider Module 1Mo M - Switched Rocker 3Mo P - Switched Rocker 2Ma Q - Switched Rocker 3Ma R - Switched Rocker 3MaMo S - Proportional Rocker 3Mo T - Proportional Rocker 3Ma	 Slider  Rocker  Micro Joystick
<u>4 Positions</u> V - Micro Joystick Z - Multi position designator (See example below)	
*Refer to handle options on website for more information	

5. Side Options
N - None R - Right Handed Keypad L - Left Handed Keypad A - Right Handed Enclosure *(position P9) B - Left Handed Enclosure *(position P10) <i>*specify up to 2 functions from Function Types for positions 9 & 10</i>
6. Mounting Options
N - None or JSM/JSL installed
<u>Mounting Bushing</u> A - Adapter Bushing - 1/4" Hole B - Adapter Bushing - 10mm x 1.5 C - Adapter Bushing - 10mm Set Screws D - Adapter Bushing - 12mm x 1.25 E - Adapter Bushing - 12mm x 1.5 F - Adapter Bushing - 12mm x 1.75 G - Adapter Bushing - 14mm x 2 H - Adapter Bushing - 5/8" NC J - Adapter Bushing - 14mm x 1.5 K - Adapter Bushing - 3/8" NC L - Adapter Bushing - 1/2" NC M - Adapter Bushing - 9/16" NC
<u>Clamping</u> P - Clamping Bushing 12mm Q - Clamping Bushing 14mm
7. Mounting Studs
N - None or JSM/JSL installed R - 12mm x 1.75 x 40mm socket Set Srew S - 10mm x 1.5 x 40mm Straight Stud T - 9/16" x 75mm wire exit, Straight Stud U - 14mm x 2 x 50mm Bend Stud @ 22 degrees V - 14mm x 2 Bend Stud @ 28 degrees W - 12mm x 1.75 x 40mm, Bent Stud X - 12mm x 1.75 x 70mm, Drilled Bent Stud Y - 5/8" NC - 14mm x 85mm wire exit, Bent Stud Z - 14mm x 2.0 x 40mm Straight Stud
8. Boot Mounting
N - None S - Square R - Round

9. Wire Length Options
xxx Inches
10. Electronics #1 and #2
N - None A - Dual Danfoss DA2 B - Caterpillar Interface DA2C2 C - Diode - Diverter Protection DPd D - Power Supply PS5 5VDC E - Single Driver Board SDB <i>*Refer to Control Electronics on website for more information</i>

*Faceplate Location Reference

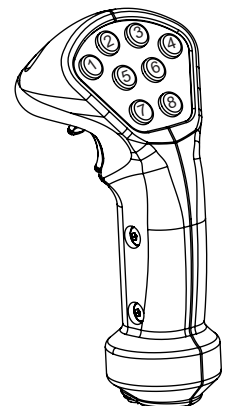

Example Guide

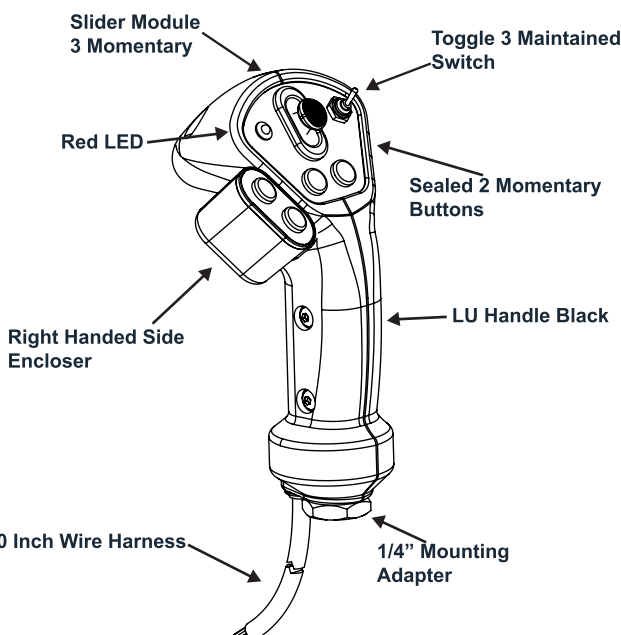
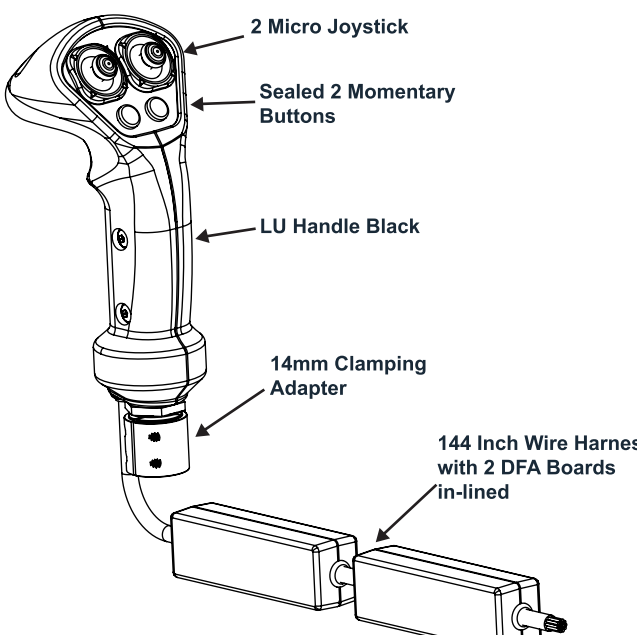
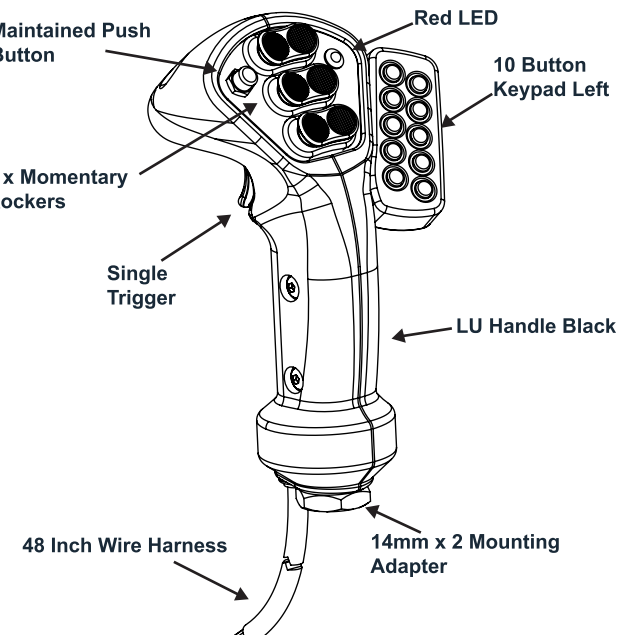
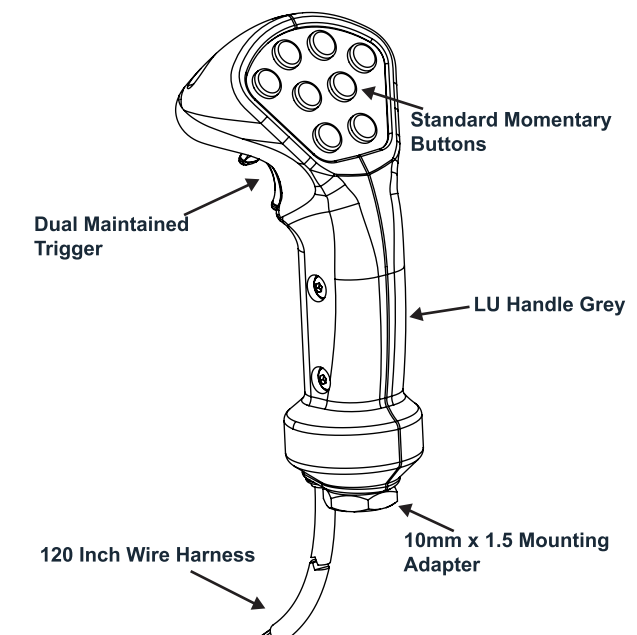
<p>LE Example 1 LU-B-B-NN-FJNDNZAAAA-A-N-N-120-N-N</p>  <p>Slider Module 3 Momentary</p> <p>Toggle 3 Maintained Switch</p> <p>Red LED</p> <p>Sealed 2 Momentary Buttons</p> <p>Right Handed Side Encloser</p> <p>LU Handle Black</p> <p>120 Inch Wire Harness</p> <p>1/4" Mounting Adapter</p>	<p>LE Example 2 LU-B-B-NN-VZVZZAANN-N-Q-N-N-144-A-A</p>  <p>2 Micro Joystick</p> <p>Sealed 2 Momentary Buttons</p> <p>LU Handle Black</p> <p>14mm Clamping Adapter</p> <p>144 Inch Wire Harness with 2 DFA Boards in-lined</p>
<p>LE Example 3 LU-B-B-SN-BMZFMZMZN-L-G-N-N-048-N-N</p>  <p>Maintained Push Button</p> <p>Red LED</p> <p>10 Button Keypad Left</p> <p>3 x Momentary Rockers</p> <p>Single Trigger</p> <p>LU Handle Black</p> <p>48 Inch Wire Harness</p> <p>14mm x 2 Mounting Adapter</p>	<p>LE Example 4 LU-G-A-DN-AAAAAAAANN-N-B-N-N-120-N-N</p>  <p>Standard Momentary Buttons</p> <p>Dual Maintained Trigger</p> <p>LU Handle Grey</p> <p>120 Inch Wire Harness</p> <p>10mm x 1.5 Mounting Adapter</p>